

ANTENNAS

A practical approach to HF and
VHF antennas, plus antenna

MYTHS and MYSTERIES

By Terry Graves, K7FE

Rev A
© 2008 & 2009
K7FE



Information was gathered far and wide for this presentation

It is my intent to dispel some common antenna myths as well as provide practical aspects of antennas . Too often “old wives tales” about antennas are passed along to new radio amateurs as “gospel” when in fact it is flawed theory. Mathematics were left out of this presentation for simplicity. The equations are available in the reference material for those of you versed appropriately.

Your antenna system is probably the single most important part of your station, take the time to make it work properly.

Think “ANTENNA SYSTEM” not just:

- **The antenna**
- **The coax or feedline**
- **The radials**
- **The balun**
- **The ground**
- **The matching network**

Everything works in tandem. If one part is not performing, then the other parts are brought down. Big Gun stations make sure that all parts of their antenna system are working properly.

Kirchhoff's Current Law

At every node, the sum of all currents entering a node must equal zero. What this law means physically is that charge cannot accumulate in a node; what goes in must come out.

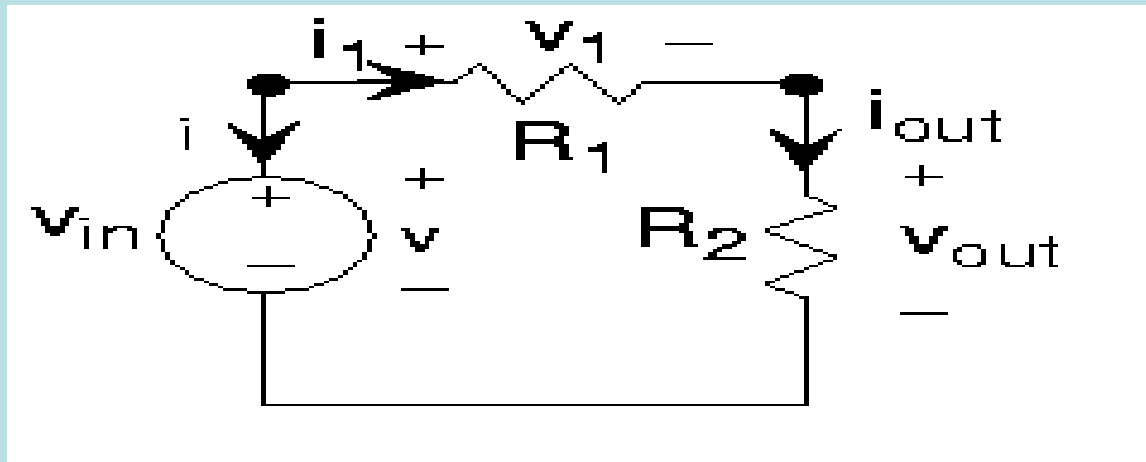

Your antenna is a series circuit. Both sides of your antenna have the same amount of current flowing in them. That means that a vertical's radials carry the same amount of current as the vertical element.

Radials

- **The commercial broadcast standard for radials on an HF vertical is 120 1/4 wave wires “buried” two to three inches** to achieve the best low angle performance. Those experiments were performed by G.H. Brown, “Ground Systems as a Factor in Antenna Efficiency” Proceedings IRE (now IEEE), June 1937, p 753.
- More recent HF tests by Al Christman – KB8I; “Elevated Vertical Antenna Systems,” QST, August 1988, p 35; have shown that **fewer “elevated” radials will perform about as well as 120 ground mounted ones.** A base mounting height above ground of about 1/10 to 1/16 of a wavelength seems optimum for 4 radials.....but will vary with soil conductivity.
- **Poor soil requires more elevated radial height for the same effectiveness.**
- **Your roof or patio cover is an excellent location to mount an HF vertical/radials** and take advantage of the “less radials required at a height” phenomena.
- **Bend them if you must.** When you do not have room for full length radials, cut them full size and then bend them as required to fit your location. They will be slightly less efficient, but perhaps not noticeably.

Here is the pattern of the I-MAX 2000, a half wave
10/11M vertical antenna.

It is sold without radials, but really needs them.

Notice the very high angle of radiation. (54deg.)

* **Total Field**

Horizontal Pol

Vertical Pol

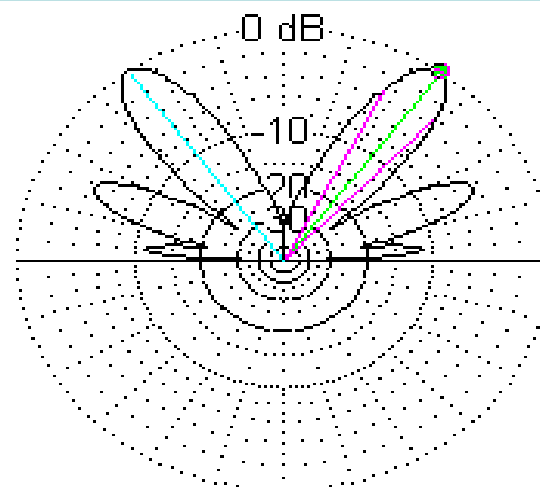

EZNEC+

28 MHz

Elevation Plot
Azimuth Angle 0.0 deg.
Outer Ring 6.62 dBi

Cursor Elev 54.0 deg.
Gain 6.62 dBi
0.0 dBmax

Slice Max Gain 6.62 dBi @ Elev Angle = 54.0 deg.
Beamwidth 15.4 deg.; -3dB @ 47.0, 62.4 deg.
Sidelobe Gain 6.62 dBi @ Elev Angle = 126.0 deg.
Front/Sidelobe 0.0 dB

The same $\frac{1}{2}$ wave antenna with optimized feed line and mast length makes a better DX antenna.
 Note: a low 6 deg. angle for maximum gain.

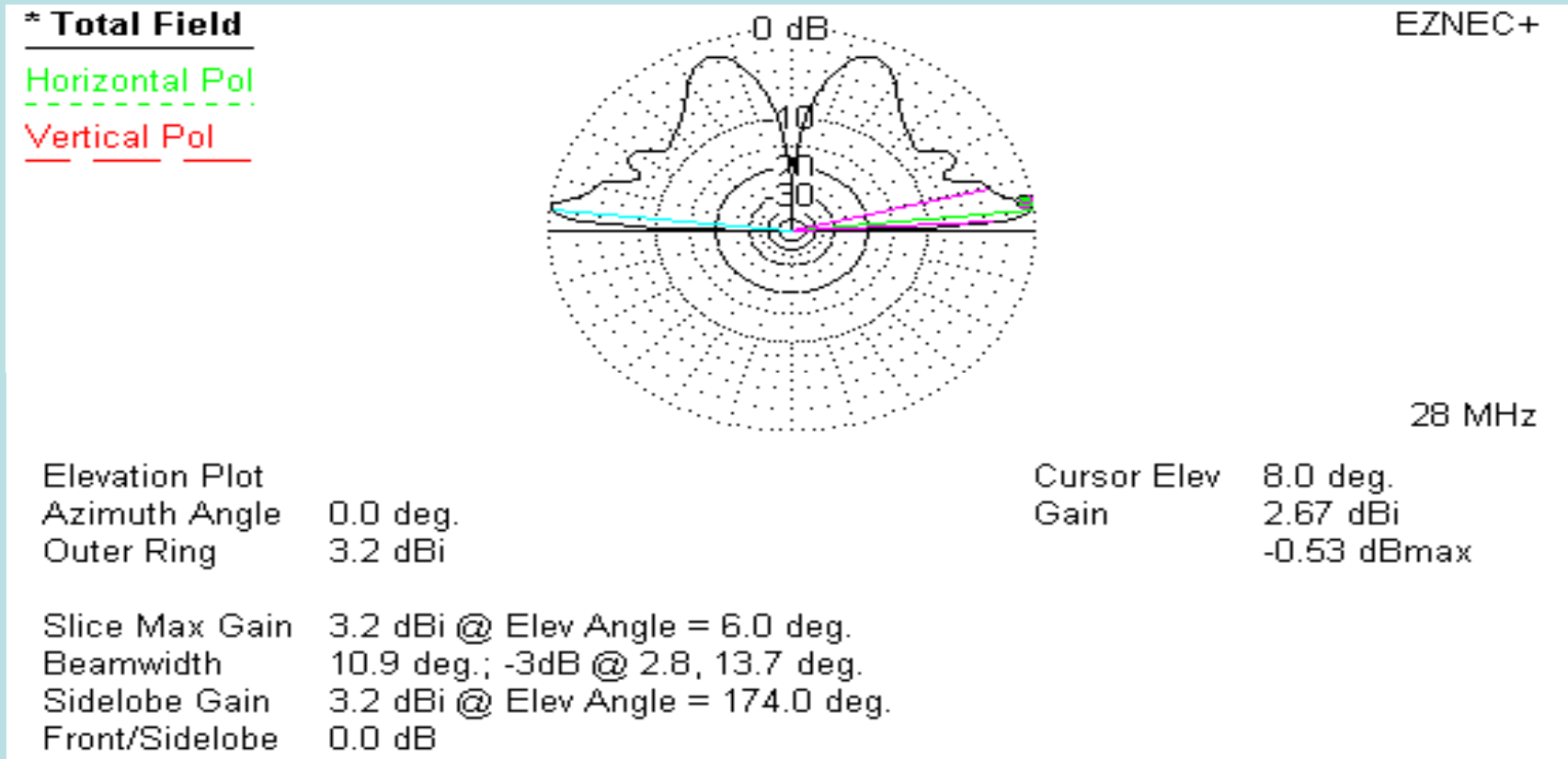

Feedline “optimization” (cut to length) is suggested by the manufacturer, because the outside of the coax shield would then act like a single vertically mounted radial. A balun at the antenna base would prevent that “radial” effect of the coax shield and degrade overall antenna performance. A good set of horizontal radials will generally out perform the “cut coax to length” approach.

Note: A $\frac{1}{2}$ wave “end fed” antenna without radials has less gain than a $\frac{1}{4}$ wave ground plane.

* Total Field

Horizontal Pol

Vertical Pol

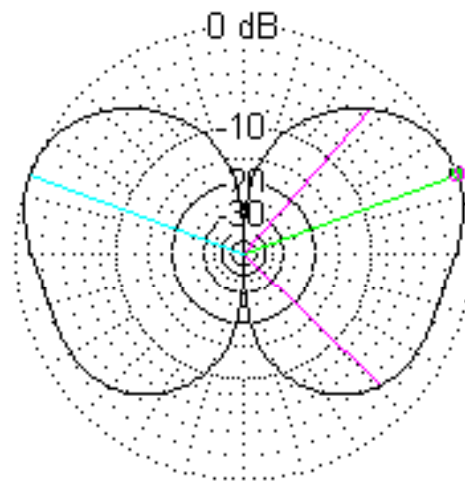

Elevation Plot
Azimuth Angle 0.0 deg.
Outer Ring 2.35 dBi

Cursor Elev 20.0 deg.
Gain 2.35 dBi
0.0 dBmax

Slice Max Gain 2.35 dBi @ Elev Angle = 20.0 deg.
Front/Back 2.18 dB
Beamwidth 93.3 deg.; -3dB @ 315.5, 48.8 deg.
Sidelobe Gain 2.35 dBi @ Elev Angle = 160.0 deg.
Front/Sidelobe 0.0 dB

Radials

Secrets your Mother never told you.

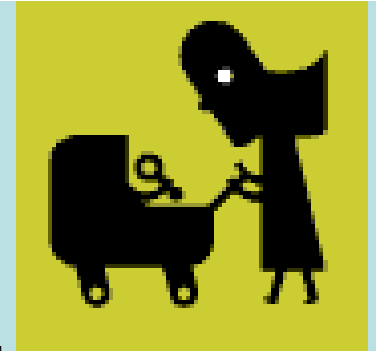

- Elevate your radials. When the base of your $\frac{1}{4}$ wavelength vertical antenna is mounted about $\frac{1}{16}$ of a wave length above the earth and four $\frac{1}{4}$ wave radials are attached there, your radial system will perform “about” as well as 120 buried radials. (120 buried radials is the broadcast industry standard) $\frac{1}{16}$ of a wavelength on 40M is about 8 feet. Radials “bent” to fit small lots will work, but will not be optimum.
- A half wave vertical “likes” it’s radials to be longer than a $\frac{1}{4}$ wave. In fact the highest radiation current density exists at about 0.35 wavelengths from the base of the voltage fed half wave vertical. That means 0.25 wavelength radials will be too short to deal with much of the return current and your ground losses will go up. Half wavelength long radials would be a better choice in this case.
- Nix ground rods. A ground rod at the base of your vertical antenna will not replace “radials.” Ground rods are fine for “DC” grounds, however are high impedance at RF frequencies. Yes, even if you bury it deep and install three of them.
- Insulated copper wire will work as well as bare copper wire for radials and stranded or solid makes no difference. Stranded flexes better in the wind. Given the high price of copper today, galvanized electric fence wire will work quite well for quick and cheap radials..... if not buried. The RF travels on the surface of the galvanizing and not deep where the steel is. Buried galvanized wire “rusts” and rust provides a horrible path for RF.

**J-pole
antenna
or
copper
cactus**



J-pole with coax center conductor connected to the “long” element

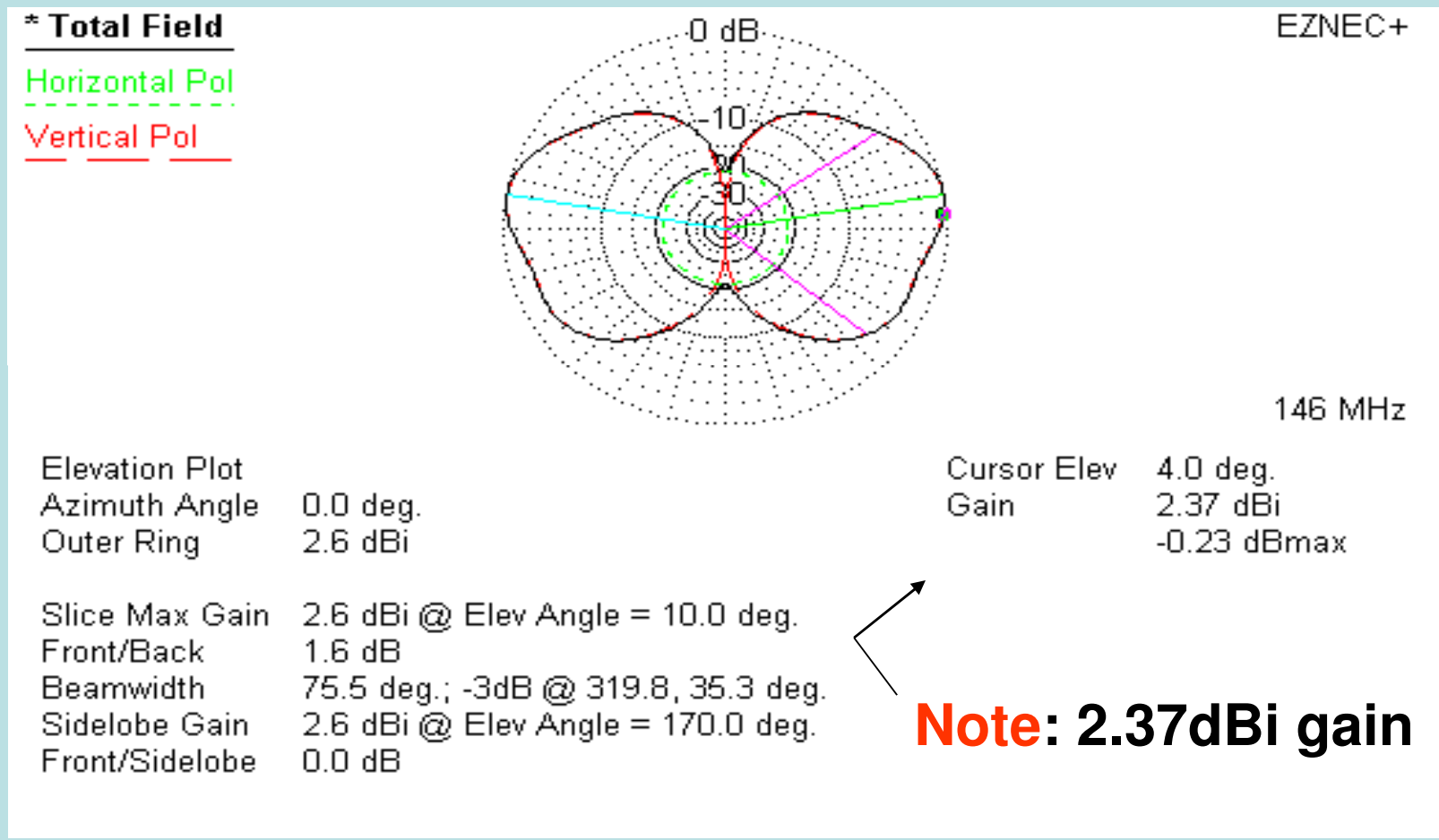

This is the preferred coax connection method. The previous photo shows the incorrect way.

J-pole with the coax center conductor connected to the “short” element

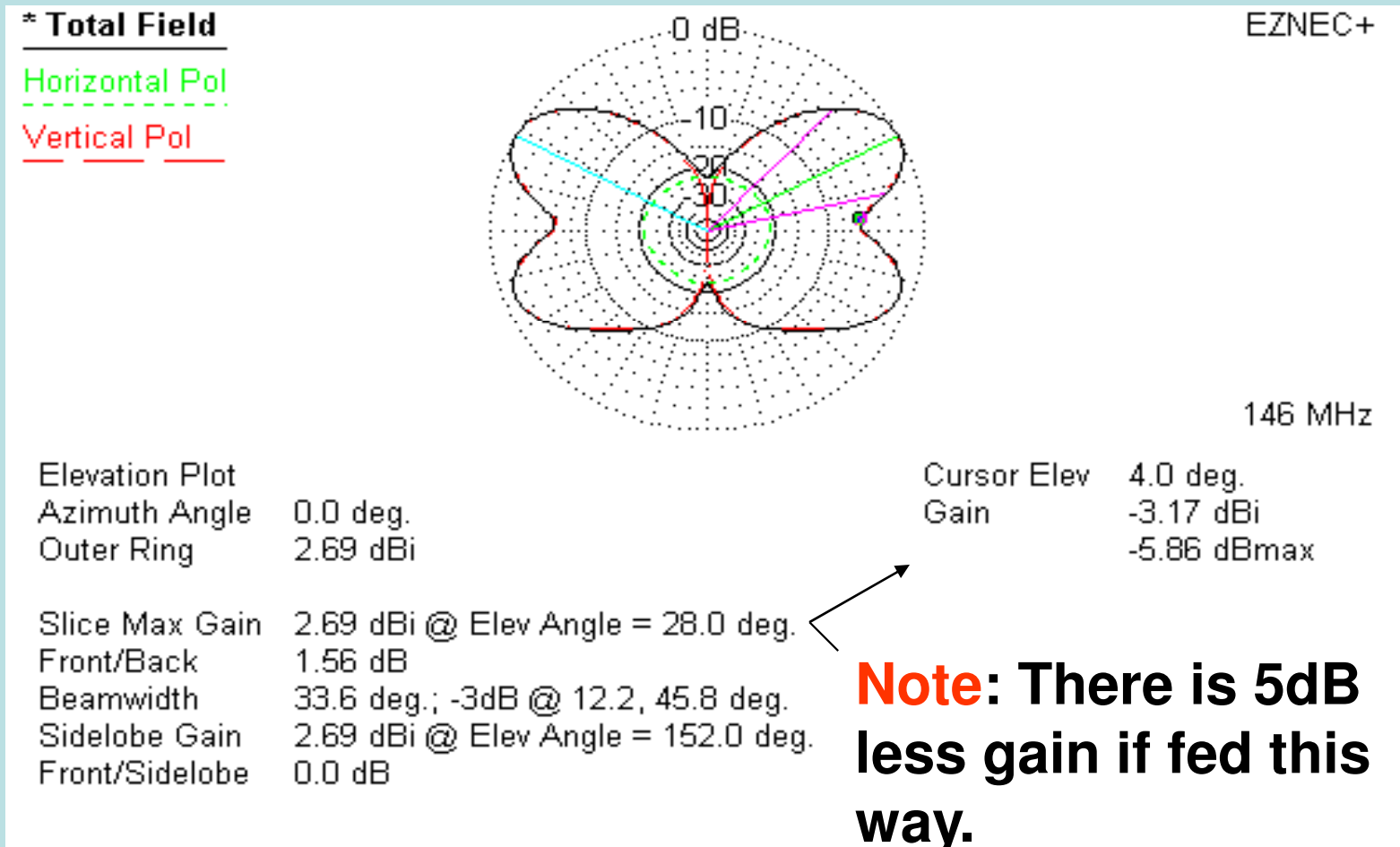

Many builders mistakenly connect their coax this way (as shown in the photo) and loose 5dB

The bad news:

You will find that there are ZERO J-poles being used as antennas for commercial repeaters.

- **Their performance at a specific site is unpredictable because the j-pole antenna interacts with nearby objects like the coax, mast, tower, building, etc.** Pattern and gain predictability is crucial in commercial work where installations are modeled. Site/install variables that interact with a J-pole are almost impossible to model.
- **Second, the resulting gain of a J-pole may be less than a properly made 1/4 wave ground plane.** Some amateur radio J-poles will work reasonably well and others will not, thus the anecdotal "good performance" stories. Good results compared to what?
- **A J-pole, like ANY end fed antenna, needs radials, a counterpoise or ground plane to work properly. Most J-poles use the outside of the coax shield for that purpose.** If you deprive it of the coax shield to obtain balance then it will use the mast, tower and other nearby conductive objects. A balun or ferrite choke at the antenna base will block or limit the current that is allowed to flow on the outside of the coax shield and reduce the J-pole's performance.
- **The J-pole is one antenna that probably should not have a balun for the above reason, should you decide to try this poorly conceived antenna.**
- **A "copper cactus is fun to build, but a ground plane will usually out perform it.**
- **J-poles are high on the list of MYTHS, that fail to live up to the claims.**

Grounds

There are four, yes four, count them
Each has it's own purpose.

- **Lightning protection ground**
- **Safety ground**
- **RF ground**
- **Induced Ground Current ground**

Grounding is often misunderstood and subject to many myths.

There is some overlap, however for the most part each is different. Not all are needed in every situation. One will not necessarily work for the other.



Lightning Ground



Do you really think unplugging your coax and laying it on the table will prevent this from traveling another few feet to your equipment?

A dramatic photograph of a lightning bolt striking a dark, stormy sky over a landscape. The lightning bolt is bright white and jagged, descending from the top center towards the bottom center. The sky is a deep, dark blue with some lighter, hazy clouds. The overall mood is intense and powerful.

Lightning may travel miles to reach you.....Don't be a victim.

Read the excellent prevention methods here:
<http://members.cox.net/pc-usa/station/ground2>
and on K9STH's site.

Glen Zook, K9STH
www.k9sth.com
lightning protection

RF Grounds with long leads using small gage wire are ineffective, no matter what you connect to.



RF in the Shack

- Many people assume that RF in the shack or (worse yet) RF burns are tied to problems from poor station grounds. Properly balanced coaxial or open wire feed lines with balanced antennas should contribute minimal RF at the operating position, even absent a shack ground! RF in the shack should be treated like an alarm bell, it is saying “There is a **balance issue** in the feed line and/or antenna.” Don’t just ground it and “mask” the problem.
- End fed antennas are notorious for imbalance and stray RF or RFI. When you run a long-wire or some other single wire feeder (a radiator) directly into the shack it will often contribute high levels of RF into the shack, so it is best to connect to a remote tuner outside of your shack. Then bring coax from the tuner to your operating position.



Myths

&



Fairy Tales

Consultants



Myth: Open line feedlines radiate more than coax

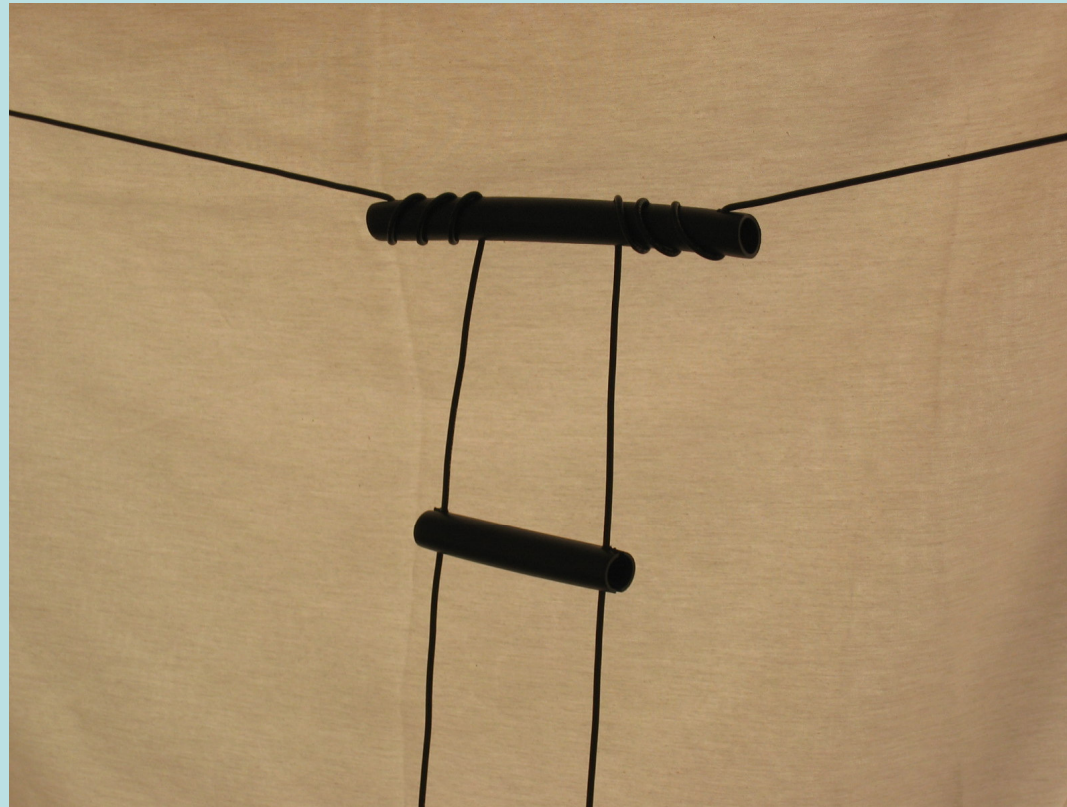

Myth: Open line feedlines radiate more than coax

- False
- A balanced open line or ladder line feed system will radiate no more than coax when properly installed.
- A field intensity measurement around your feed line will prove this.
- If your feedline radiates, it and/or your antenna is out of balance and needs to be corrected.

True open wire line

From Terman, Radio Engineering, 2nd ed. p 700:

"The losses in a properly constructed line can be made very small. Thus by combining [equation references ...] it is found that a two wire line made from No. 4 copper wire and having a characteristic impedance of 600 ohms introduces an attenuation of 0.24 db per thousand feet at 10 mc."

*WOW, that is low loss.
"RG-8 has 5.5dB of loss"*

He continues:

"A two wire transmission line radiates very little energy because the close proximity of the two conductors carrying current in opposite directions very nearly cancels the radiated field. Analysis shows that in the case of a perfectly balanced two-wire line the total radiation, including that of the terminal connections, is twice the radiation that would be obtained from an elementary antenna having a length equal to the line spacing ... "

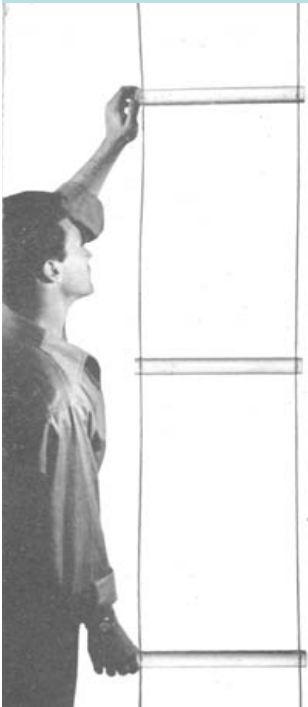

Feedline Balance

Many people think a balanced feeder has exactly equal currents in each leg. ***That's correct, but it does NOT go far enough!***

The correct and complete rules for a balanced feeder are:

- Both conductors must have equal currents
- Each conductor must have currents 180 degrees out-of-phase with the other conductor at the same point
- Each conductor must have equal and opposite voltages with reference to ground or the spatial area around the conductors. As with current, the voltages must be 180 degrees from each other.
- Unless all of these conditions are met, the feedline could be a source of unwanted energy leading to RF in the shack or noise ingress into the antenna.

Myth: $\frac{1}{2}$ wave vertical antennas like a J-pole do not need radials.

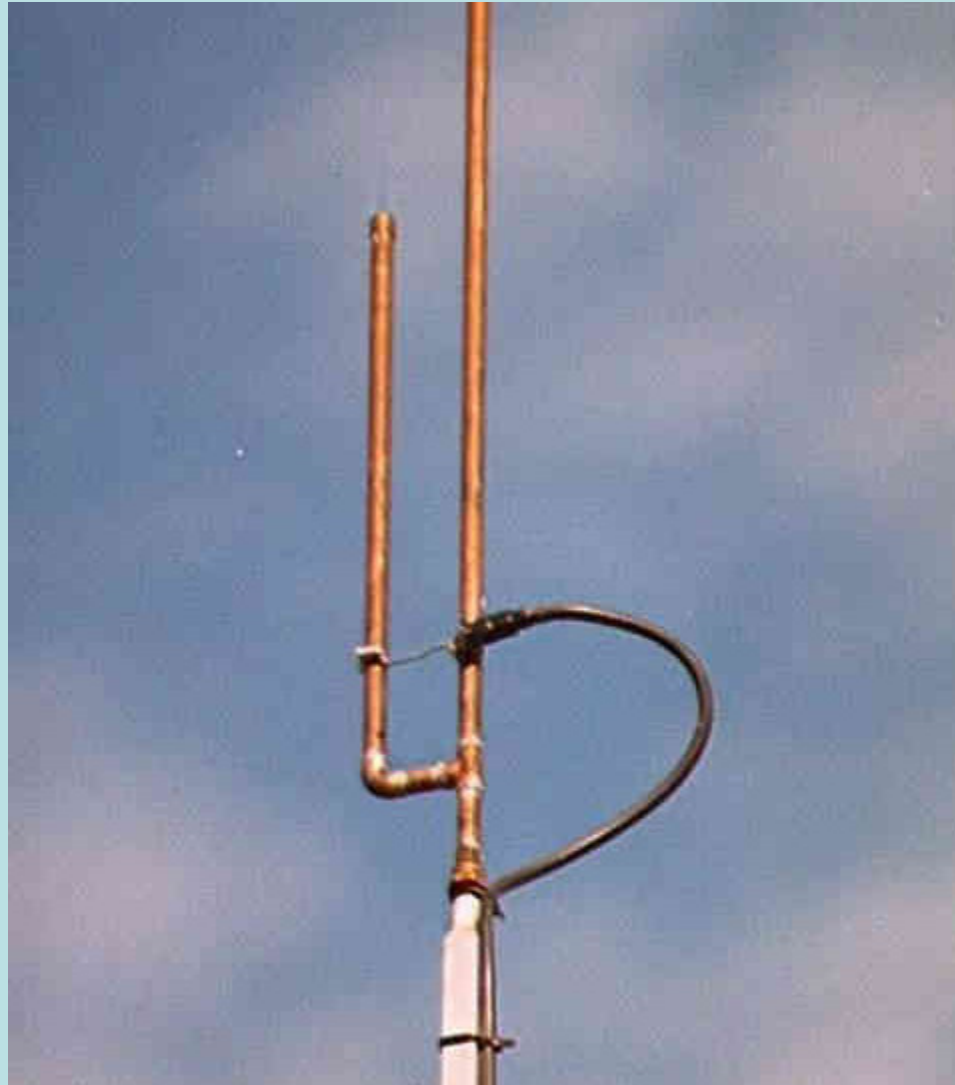

Myth: $\frac{1}{2}$ wave vertical antennas like a J-pole do not need radials.

- **False**
- The J-pole is a worse-case situation for examining unwanted feedline radiation.
- In the case of the J-pole without radials, all of the common mode current created by the poor feed system flows over the coax shield and mast. The mast and coax is generally vertical and as high and clear as the actual thing we think is the antenna, and so unwanted radiation from the feedline is quite apparent and part of the reason that the J-pole “sort of works.”
- One should NOT use a balun at the base of a J-pole. The balun would block current on the outside of the coax shield and further reduce the effectiveness of the J-pole antenna.
- ALL end fed antennas do need radials or a counterpoise to work properly. The radials are the other half of the antenna and carry current equal to that on the radiator.

Myth: All antennas need a ground.

True or false?

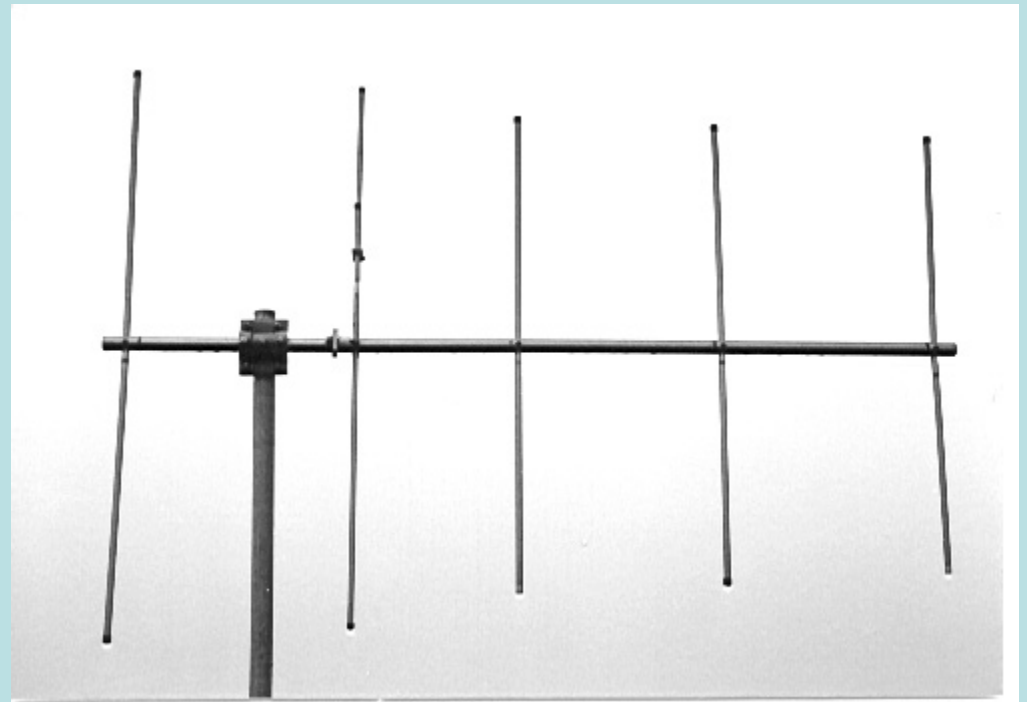
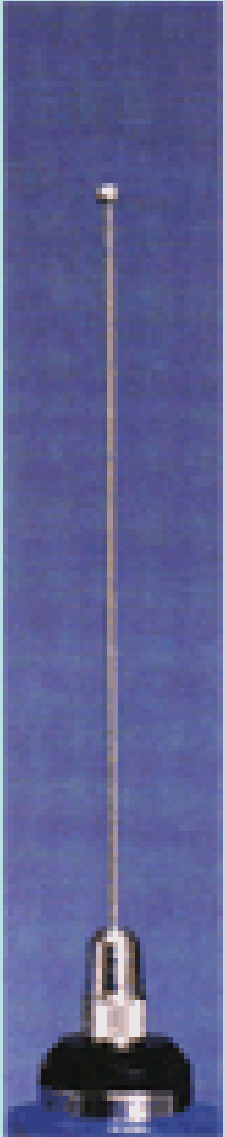

Myth: All antennas need a ground.

False

Some antennas need an RF ground to complete the other half of the antenna.

Examples:

- **HF and VHF/UHF Mobile antennas use the vehicle body as a counterpoise/ground/ground plane.**
- **End fed Vertical antennas need radials or another form of RF ground. This includes all end fed antennas like the J-pole, long wire, Zepp and Windom.**
- **The above antennas and some others need an RF ground return in the form of radials, counterpoise or ground plane to be “complete.”**

Many antennas are self completing and do not need an RF ground.

Here are some examples of antennas that do not need an RF ground:

Dipole, Yagi, Cubical Quad, Loop, Rhombic, others



Do I need a better
RF ground?

40 meter Hustler antenna
& ICOM 706MII on
electric scooter

YES !!!!!

The small metal frame and fiberglass body do not provide anything close to a 33 foot $\frac{1}{4}$ wave radial for 40 meters.

I did make contacts in spite of the extremely poor radiating system. Was it optimum? No

My signal reports were “weak,” even with 100 watts.

Do not let a pathetic antenna prevent you from operating that moment. Make improvements when you can. I have worked many stations using a clip lead for an antenna, however I prefer a 6 element wide spaced Yagi mounted a half wavelength or higher above ground.

Myth: A 5/8 wave antenna has 3dB more gain than a ground plane.

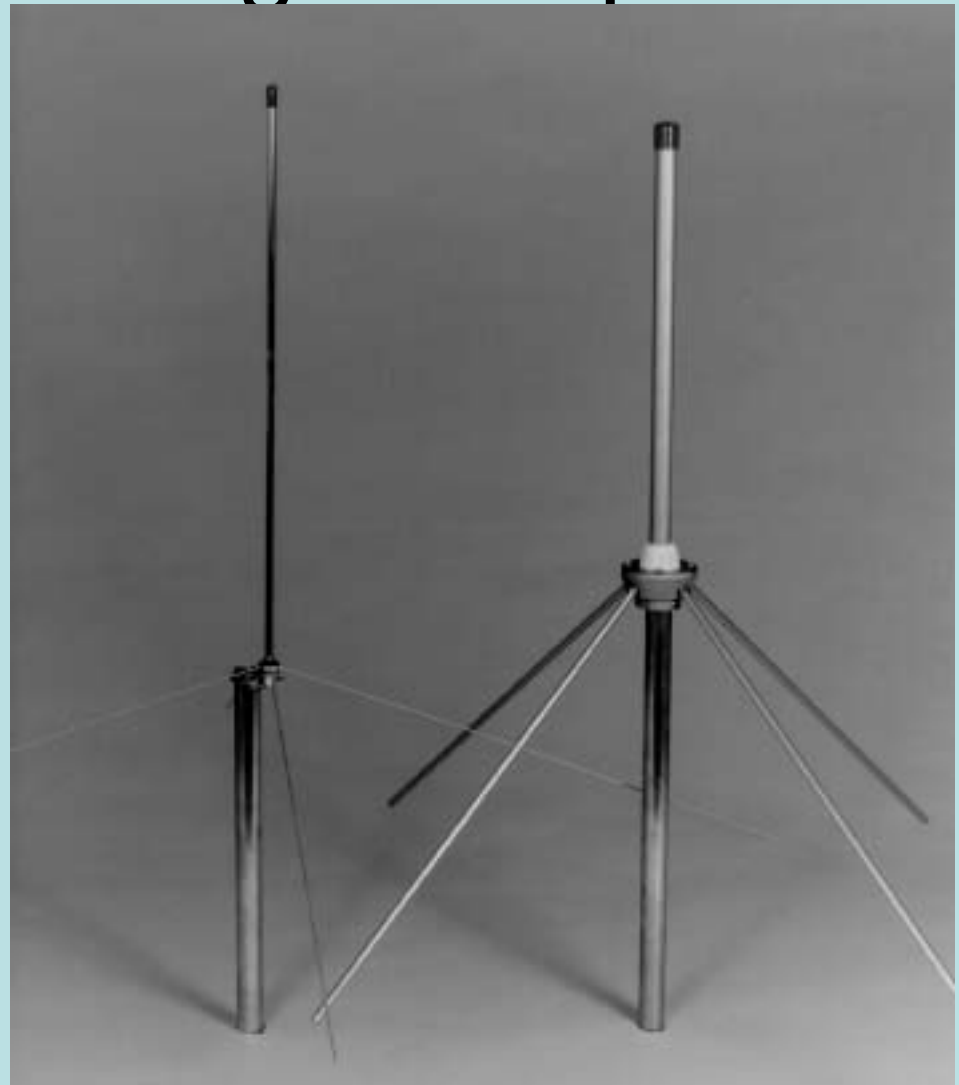
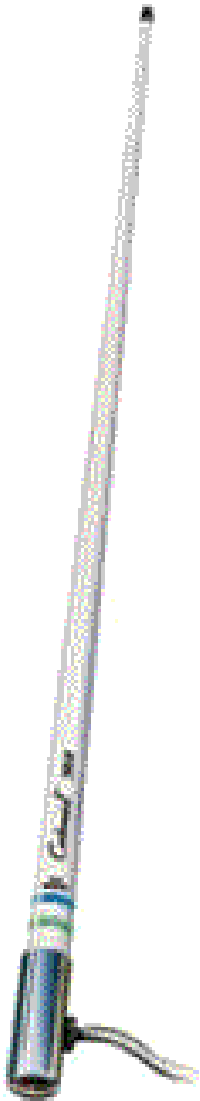

Myth: A 5/8 wave antenna has 3dB more gain than a ground plane.

False

- The losses in the required matching coil at the base of the 5/8 wave antenna reduce the gain difference to a max of about 2dB (with a perfect ground plane) to zero difference in some installations.
- Where and how you mount the antenna on your vehicle is important. The 2.85dB theoretical gain is only for a perfect loss less matching coil and with the antenna over a “perfect” infinite flat ground plane.
- Magnetic mounts provide a “much less than perfect” ground plane. They also can be a road hazard for other drivers if they bounce off of your vehicle.
- Drill a hole in the vehicle body for your VHF/UHF antenna mount, your antenna system will work much better.

What do others say about 5/8 wave antennas?

Elevation Patterns for
2-Meter Verticals:
GP-45: 1/4 WL,
45-deg radials
58-90: 5/8 WL,
90-deg radials

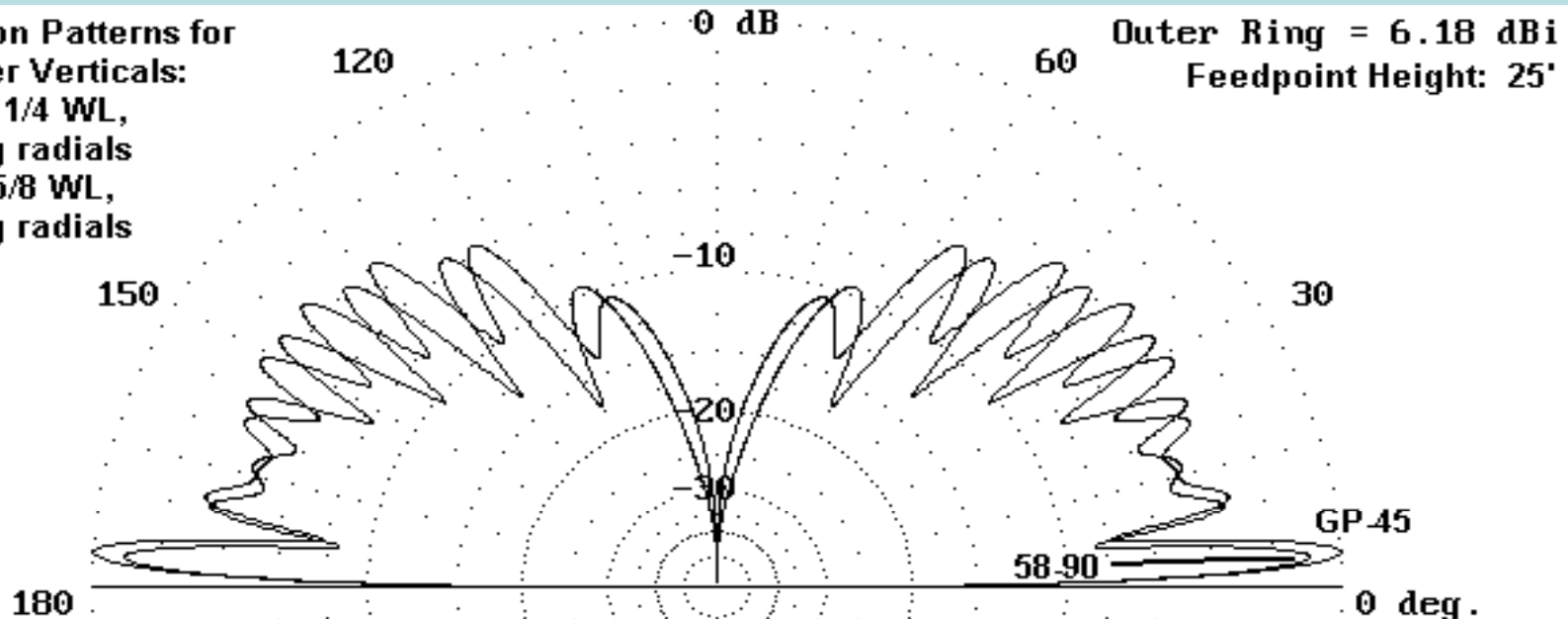

- **“In the end, it is dubious whether a 5/8-wavelength monopole has any significant operating benefit over a 1/4-wavelength monopole, each with 4 radials. Perhaps the higher top height of the longer antenna will yield some benefit when its base is very close to the ground. However, the 5/8-wavelength monopole always requires some form of matching system for use with a 50- Ohm coaxial cable, and matching systems at VHF are not without loss. At rooftop and higher levels, the sloping radial monopole with a 1/4-wavelength radiator or a half-wavelength dipole will do as well--or better”.** – L. B. Cebik, W4RNL

The collinear antennas on the left do have a higher gain than the $\frac{1}{4}$ wave ground plane on the right.

VHF/UHF Repeaters usually have antennas similar to those on the left.



VHF/UHF Myth: A poor antenna mounted high will out perform a good antenna mounted low.

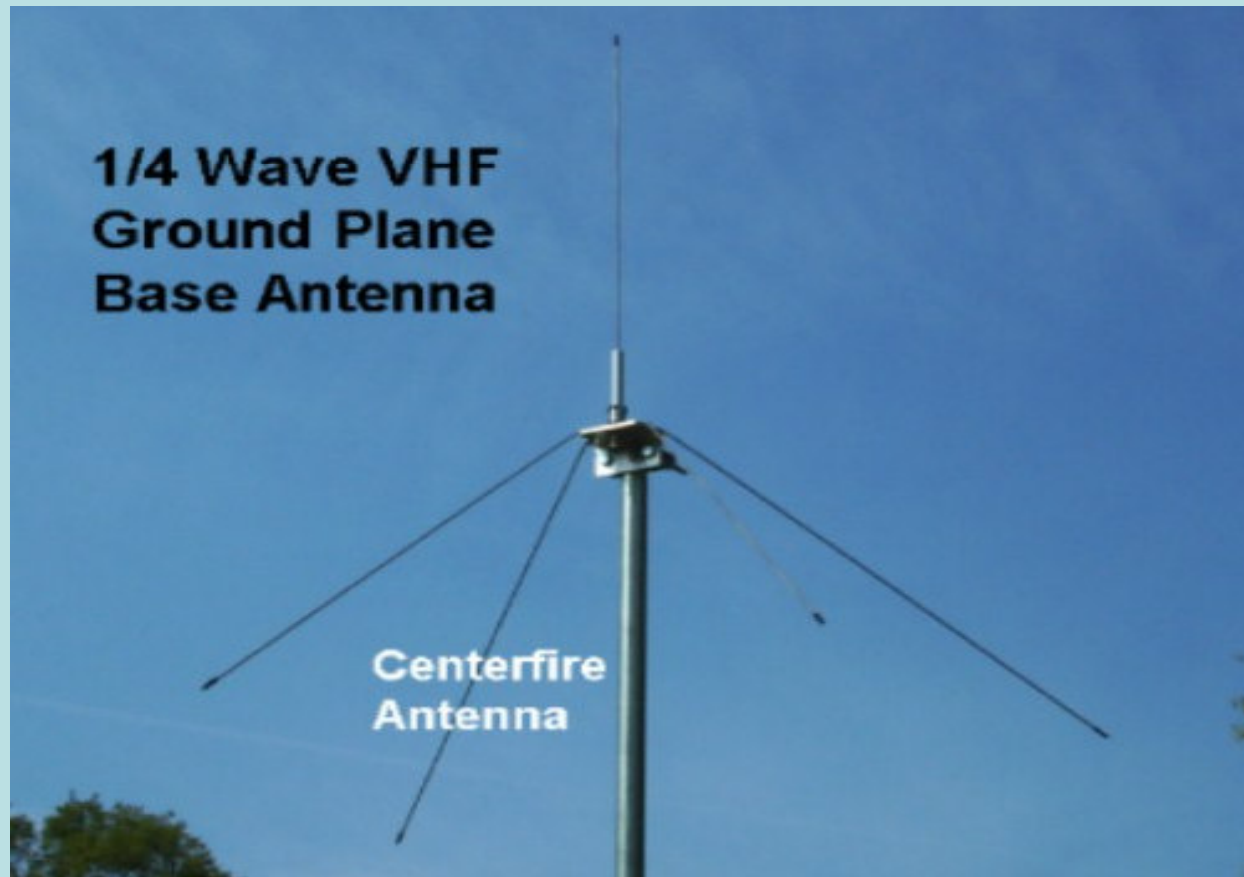

VHF/UHF Myth: A poor antenna mounted high will out perform a good antenna mounted low.

- **True**
- Height is everything. These are not called “line of sight bands” for nothing.
- Yes, I know tropo, moon, meteor bounce and some other forms may not benefit from the height.

HF antenna Height

- **Horizontal antennas** like to be about $\frac{1}{2}$ wave length high for DX (low angle of radiation).
- For NVIS contacts, (high angle of radiation), a 0.15 to 0.2 wavelength horizontal antenna height works well to send your signal straight up, bounce off of the ionosphere and down to stations within a couple of hundred miles of you.
- **Vertical antennas**, may be ground mounted for DX if you plan on installing a lot of radials, however benefit from roof mounting because fewer radials are required to achieve the same efficiency as a ground mounted vertical.

Myth: The size of my antenna does not matter.

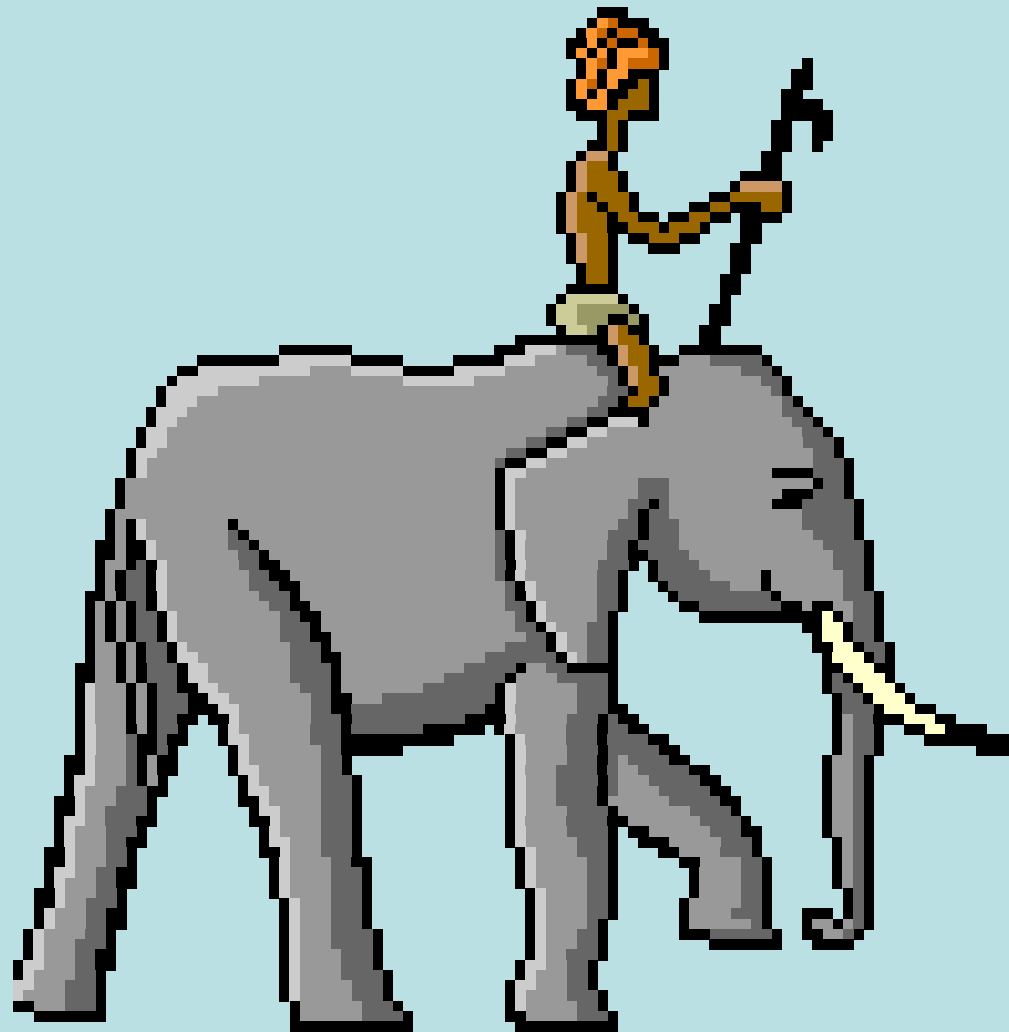

Myth: The size of my antenna does not matter.

False

Shortened antennas are less efficient..... in other words a compromise of performance. “Bigger is Better”

Antenna gain is a function of “effective” aperture or “effective” area.

Simply increasing the size of antenna does not guarantee an increase in effective area; however, other factors being equal, antennas with higher maximum effective area are generally physically larger.

Yagis with longer booms have more gain than those with shorter ones..... if they each have the same number of elements.

Myth: If I move to a hilltop, my signal will be louder and I will hear better.



Myth: If I move to a hilltop, my signal will be louder and I will hear better.

- **Not necessarily so.**
- You may have a lower noise level and hear better if you are further away from noise sources while on a hill.
- HF stations in the valley floor hear and are heard as well as the hilltop, all other conditions equal.
- The benefit to elevation is that the low angle skywave window of 2 way reception may be “longer” not louder.
- Line of sight contacts like VHF will be expanded.

Myth: My Hamstick mobile antenna has a lower VSWR than your large Screwdriver or bug Catcher



Myth: My Hamstick HF mobile antenna has a lower VSWR than your large Screwdriver or bug Catcher

- **Perhaps.**
- My dummy load has a lower VSWR than my dipole.....and more bandwidth.
- Antennas with small diameter coils and/or use small wire gage have higher losses which add in series with the antenna feed impedance to make an impedance value closer to your 50 ohm coax.....thus the better match. They will additionally have more loss and radiate less signal.

When using a Hamstick mobile antenna, think “Rubber Duck” and you will not be disappointed.

The small diameter coils are very inefficient on 40, 80 & 160. Hamsticks will perform better on the higher bands like 10, 15 or 17.





Mobile antennas



- Low loss antennas have a feed impedance that more closely reflects their theoretical impedance. 160, 80 and 40 meter antennas on your vehicles are much shorter than $\frac{1}{4}$ wavelength long, thus have a very low feed impedance.
- Bug Catcher and large screwdriver antenna's feed impedance may be as low as 2 to 15 ohms and need to be matched at the base to step them up to your 50 ohm coax impedance. The actual feed impedance changes with each band. The lower the band (like 160M), the lower the feed impedance.
- Losses in small diameter coils and small gage wires of some less efficient antennas add in series with the antennas impedance to raise the feed impedance. This lowers the VSWR.....and your signal.

WHERE you mount your HF mobile antenna is “almost”
as important as ***WHICH*** antenna you use.

- Remember, you are building an antenna system, it is not just the antenna alone. Bonding, coax, matching, capacity hat or not, mounting location and method of mounting are all part of that system.
- Antennas mounted close to the road, like bumper or hitch mounts, have greater ground losses than those mounted on top of the vehicle roof.
- Loading coils **MUST** be kept as far away from the metal vehicle body as possible.
- Magnetic or “mag mounts” do not properly couple the shield of your coax to the vehicle body. The vehicle body is the other half of your antenna and only minimal capacitive coupling to the body occurs with a mag mount. Your coax shield needs to be “solidly connected” to the vehicle body.

For those of you who are still unclear, I will restate it.

NEVER use mag mounts for an HF mobile antenna.

Preferred HF antenna Mounting locations

- **Pickup** - Bed center or $\frac{3}{4}$ back towards the rear. Upper sides of bed and half way or more back towards the rear.
- **Minivan** – Rear side panel, high near the roof line. Center of the roof works well. Keep the maximum vehicle height limit laws in mind during your installation.
- **Autos** – Trunk lid (bond it well), rear fender up high, center of roof.

Roof mounted or other locations high on the vehicle mean that a shorter whip and mast must be used to stay within legal height limits. Those systems will benefit from a capacity hat.

Poor mounting locations:

- **Pickups** - Near the metal cab. Reason: Metal too close to coil. It causes losses by coupling and it lowers the loading coil Q.
- **Minivans** – Lower side, rear bumper or hitch mounts. Reason: Metal too close and increased ground losses due to proximity to earth.
- **Autos** – Below bumper or trailer hitch mounts. Reason: Ground losses and hitch receivers, unless bonded, have an intermittent ground connection.



Notice how high the Hustler coil is above the trucks metal parts. This ham wisely kept it away to prevent interaction and losses.



This Bug Catcher mobile antenna has a capacitive “top hat” installed above the loading coil to reduce the number of turns required on the loading coil. This reduces loss thus improves efficiency.

Note the base matching “shunt” coil in the enlarged portion of the photo. Large mobile antennas have a 2 to 15 ohm base impedance and need assistance matching to 50 ohm coax.

Hi-Q-Antennas - Antenna Base Impedance Matching

The natural impedance values for the Hi-Q Series of HF Mobile Antennas are:

Hi-Q-2.5/40 @ 7.250 MHz is approx. 49 Ohms Hi-Q-2.5/80 @ 3.750 MHz is approx. 22 ohms

Hi-Q-3/80 @ 3.750 MHz is approx. 18 Ohms Hi-Q-4/80 @ 3.750 MHz is approx. 12 Ohms

Hi-Q-4/160 @ 1.850 MHz is approx. 10 Ohms. Hi-Q-5/80 @ 3,750 MHz is appx. 10 Ohms

For the 40 and 80 Meter bands, you **MUST** use a matching device to bring the feed point impedance close a nominal 52 ohms. This can be easily achieved with the supplied shunt coil. (A shunt coil may be made using #14 or heavier bare copper wire, close-wound on a 1.25" to 1.5" mandrel, and then stretched slightly to create an air gap of approximately one half of the wire's diameter between the turns--just make sure coils aren't touching each other.)

One end of the coil is attached to the antenna's feed point at the 3/8-24 bolt and the other end to goes to ground. However, before you permanently ground the coil, determine the best VSWR by simply shorting out turns of the shunt coil one-by-one until the VSWR reaches its lowest point. This is usually less than 1.5:1. Solder the ground tap at this point. You may want to test the tap at different points

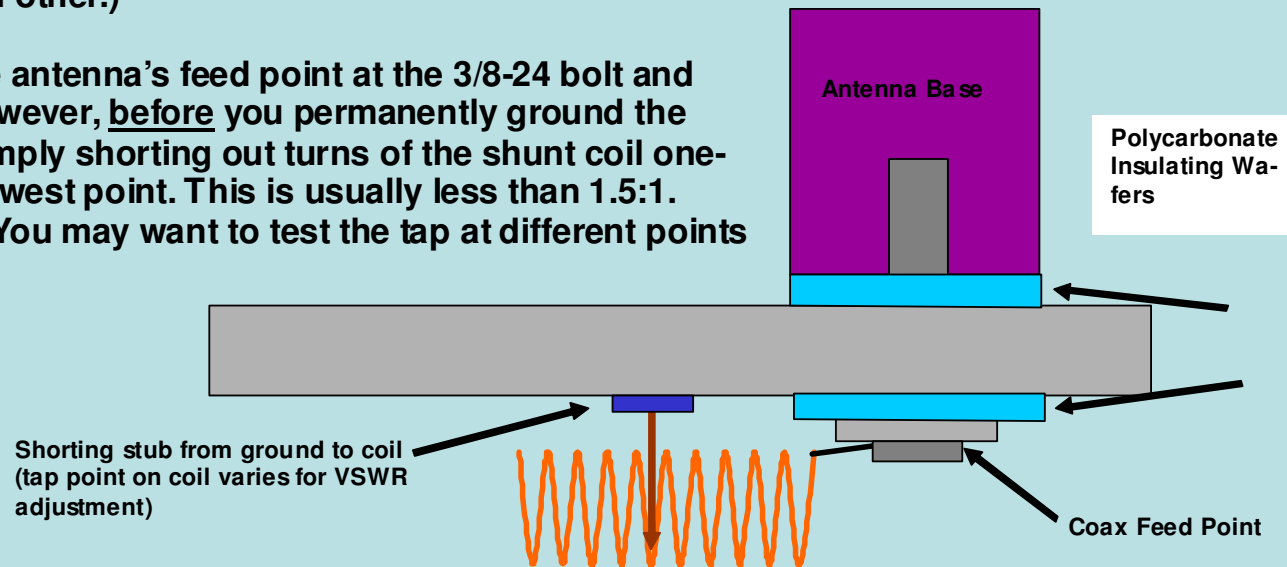



Top hat also called capacitive hat

- A large “hat” or capacitance at or near the top of the antenna allows considerable shortening of length with no loss in efficiency.
- For a given height antenna, efficiency is increased with a hat mounted one or two coil lengths above the loading coil.
- Fewer turns are required on the loading coil when using a capacitance hat and the antenna current distribution is improved.
- Less turns = less losses

KOBG, Alan Applegate

← Top “Bigger is Better”



Below are the summarized results of three 75m mobile antenna shootouts held in California during the 1980's.



Reference Antenna

Look how poor some antennas performed compared to a Bug Catcher or large Screwdriver.

12dB down (Hamstick) means only $1/16$ of the power is being radiated compared to the reference antenna..... That means that you receive signals about two S units lower also.

- 0 dB - (Reference) Bugcatcher or Screwdriver with large top hat
- -2 dB - Bugcatcher or Screwdriver with no top hat
- -5 dB - 8.5' whip with bugcatcher base loading coil
- -6 dB - Bugcatcher with Stainless Steel Loading Coil
- -8 dB - Hustler High Power system
- -9 dB - Outbacker
- -12 dB - Hamstick
- -12 dB - 11.5' whip with SGC-230 autotuner
- -14 dB - CB whip with SGC-230 autotuner (estimated, not measured)

**Doors,
Hood,
Exhaust,
Body,
Tail pipe,
Frame,
Trunk,
A/C lines
Etc.,
Should be
bonded to
each other...
In several
places.**

**Bonding is
extremely
important**

Your car body and other metallic parts make up the “other half” of your mobile antenna. Tie them together for better radiation efficiency and lower ignition noise.

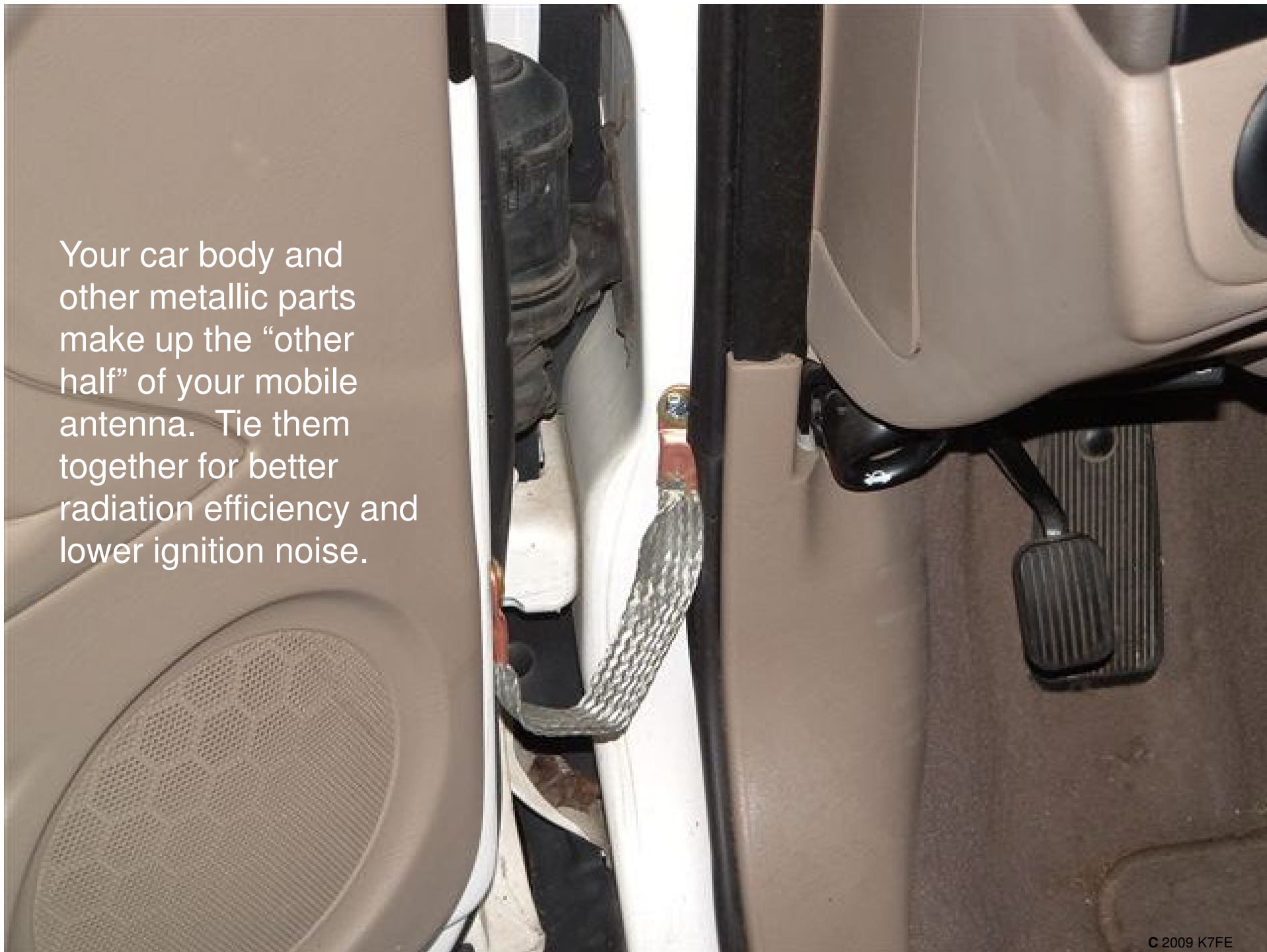

**Ground BOTH sides
of the hood and
trunk with
conductive
straps**

Copper strap has
a lower RF
impedance than
braid, but braid
flexes better.

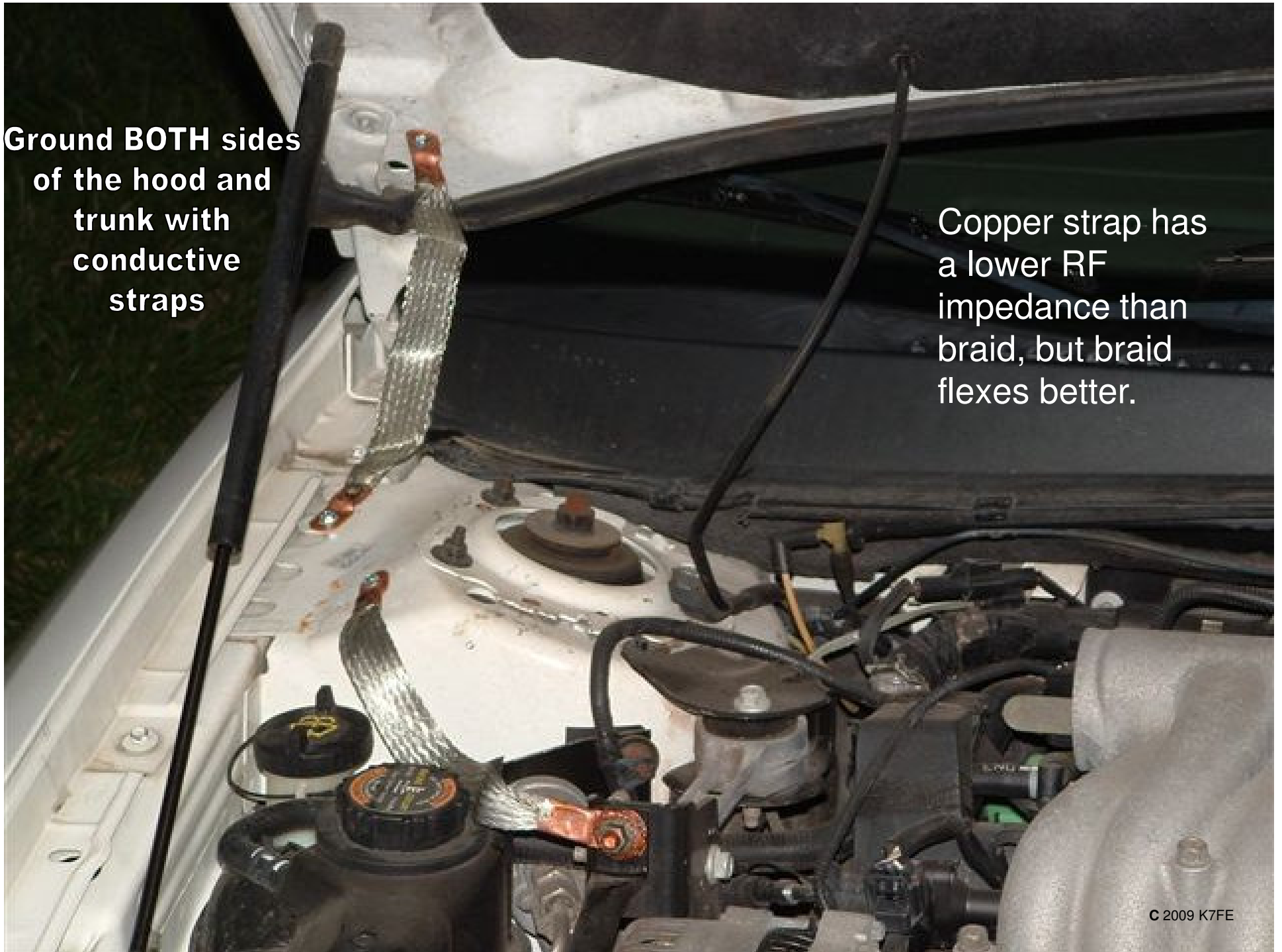

Myth: An Inductor is different than a Loading Coil or a choke.



Myth: An Inductor is different than a Loading Coil or a choke

- **False**
- They are the same, just used in different applications.
- Coiled up wire is an inductor no matter what name you call it.

Myth: Most antennas will benefit from a balun.

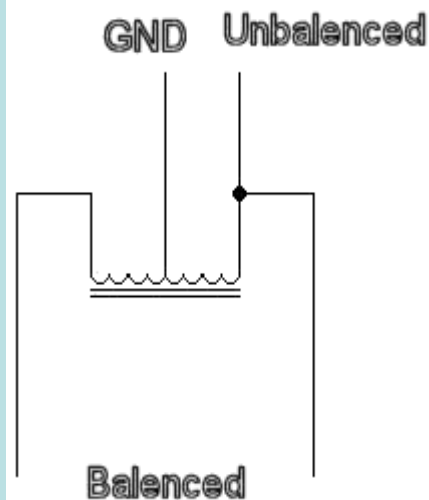
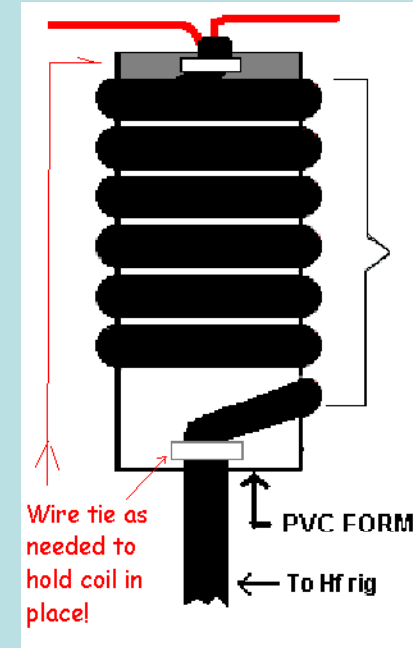

Myth: Most antennas will benefit from a balun

- **True.....** if you are attempting to obtain particular radiation patterns. Directive antennas like a Yagi will produce a more predictable pattern with fewer side lobes.
- Even our friend the ground plane with 4 radials has common mode currents flowing on the outside of the coax shield and mast. It's radiation pattern will be distorted from the theoretical one we are use to seeing.
- Dipoles will produce a more uniform "figure eight" pattern if a balun is employed at the feed point.

Does it matter? Not necessarily.

For verticals or dipoles, one of those pattern distortions we inadvertently created may be in a direction that we like to communicate.

Myth: Antennas that work for transmitting will be fine for receiving and vice versa

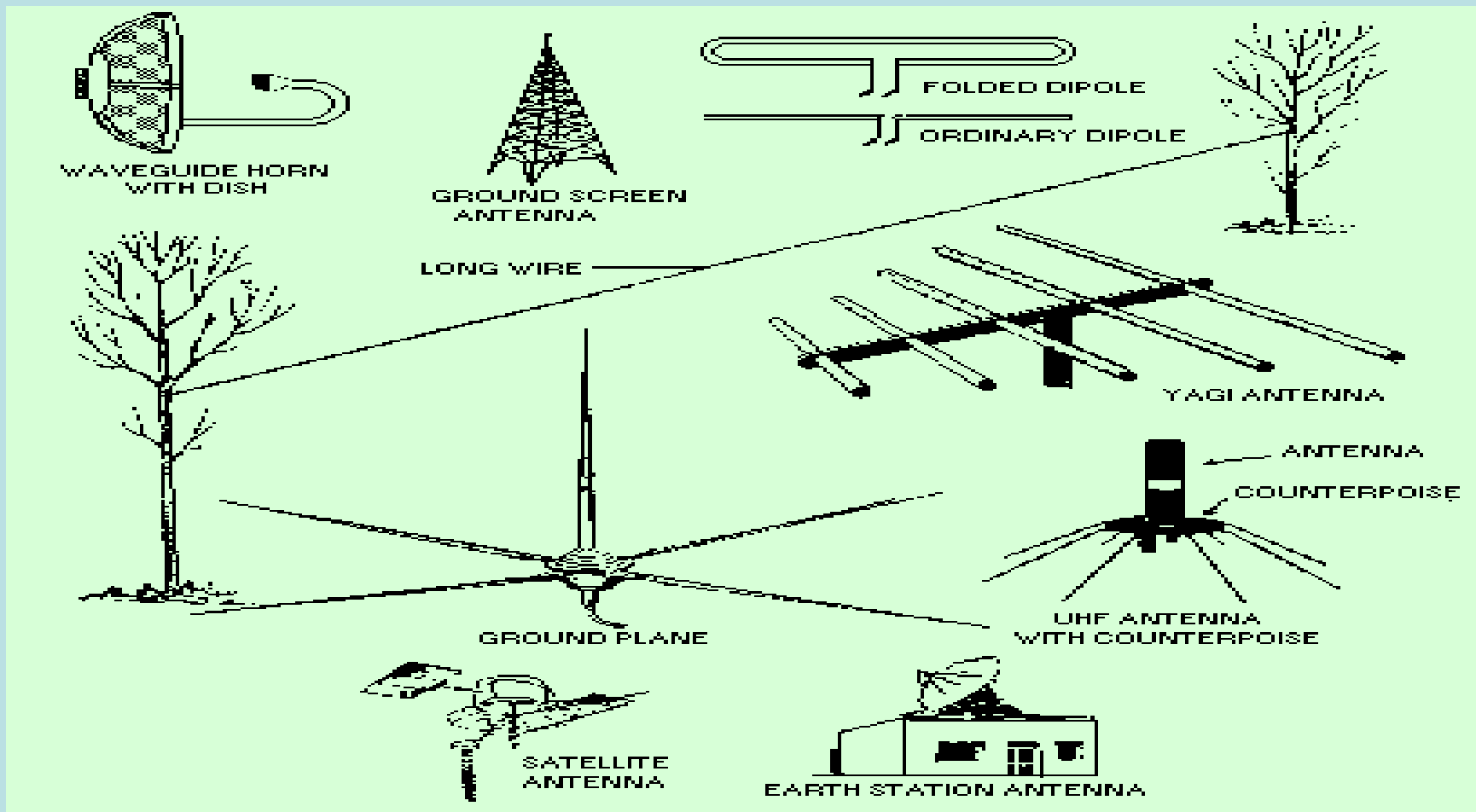

Myth: Antennas that work for transmitting will be fine for receiving and vice versa.

- **False**

- Verticals have a low angle of radiation for DX, however pick up more noise when receiving.
- The Beverage and some other “wave” antenna have low noise characteristics when receiving but are poor transmitting antennas because of their minimal height above ground and the associated ground losses. The earth acts like a ferrite bead and soaks up RF energy and dissipates it in the form of heat.

NVIS antennas

- **NVIS, or Near Vertical Incidence Skywave**, refers to a radio propagation mode which involves the use of antennas with a very high radiation angle, approaching or reaching 90 degrees (straight up), along with selection of an appropriate frequency below the critical frequency, to establish reliable communications over a radius of 0-200 miles or so, give or take 100 miles.
- **The high angle radiation of a dipole (or inverted V) can be enhanced by adding a counterpoise wire below it**, about 5% longer than the main radiating element, to act as a reflector. The optimum height for such a counterpoise is about .15 wavelengths below the main radiating element, but when the antenna is too low to allow for that, a counterpoise laid on the ground below the antenna is still effective.
- The ground counterpoise also serves somewhat as a **“induced ground current ground.”**
- **At a height of .15 to .2 wave, over excellent ground or counterpoise, an NVIS antenna’s gain can approach 7 dbi.....straight up.**

Buddipole

Semi NVIS
location

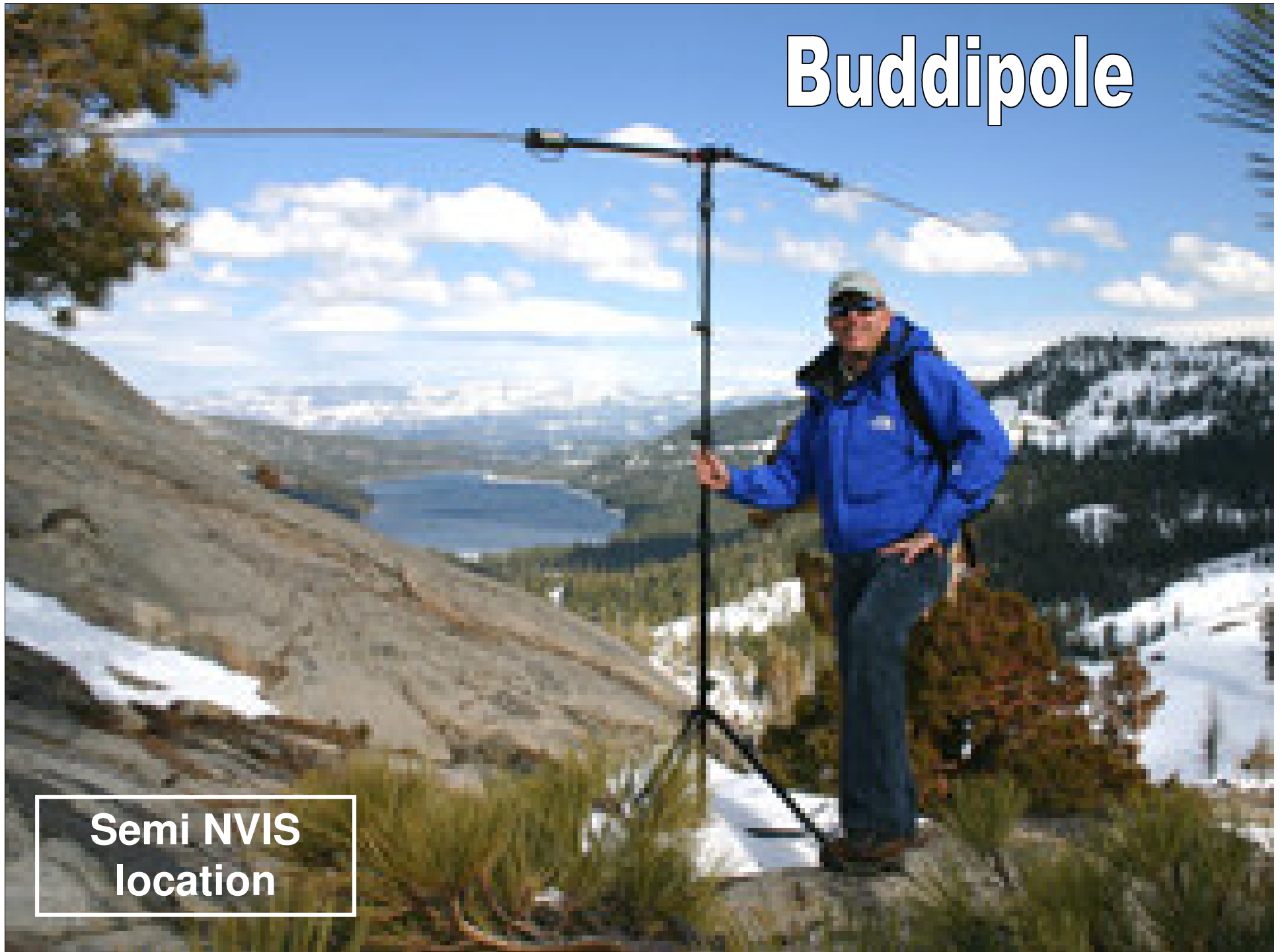

View from W6HIQ's back yard. Two of his mobile antennas used as a low dipole - - - semi NVIS radiation pattern.



Myth: Higher gain antennas receive better



Myth: Higher gain antennas receive better

- **Perhaps** They may, but not in every case.
- ***Direction and polarization of arriving signals and noise constantly vary, and so the relative relationship of each to any individual antenna's response will vary.***

Myth: Linear Loading is more efficient than conventional coil or lumped loading

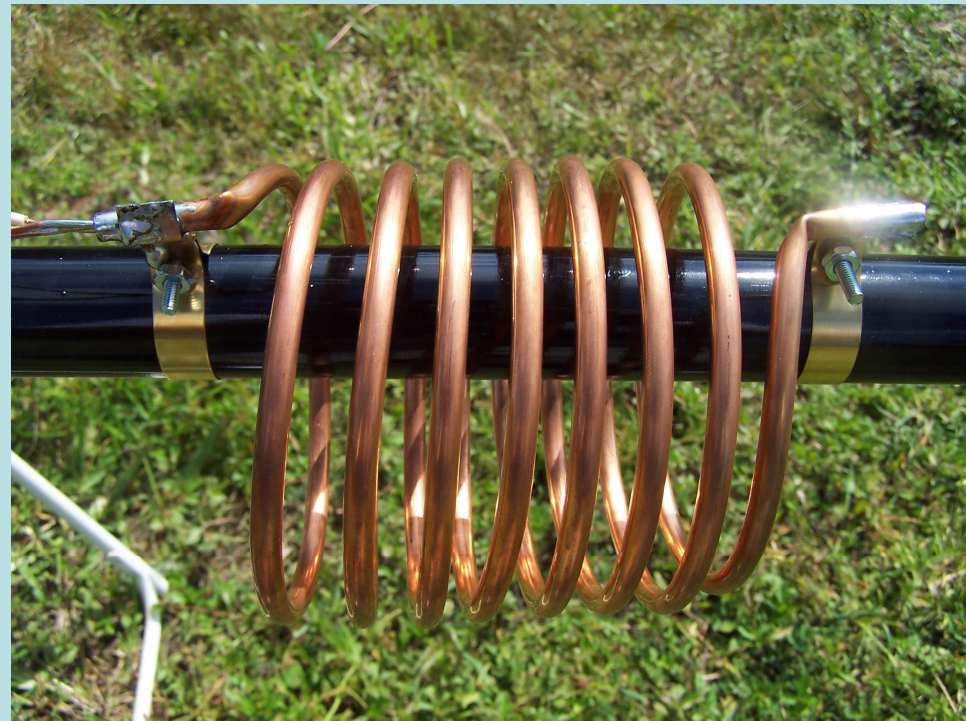
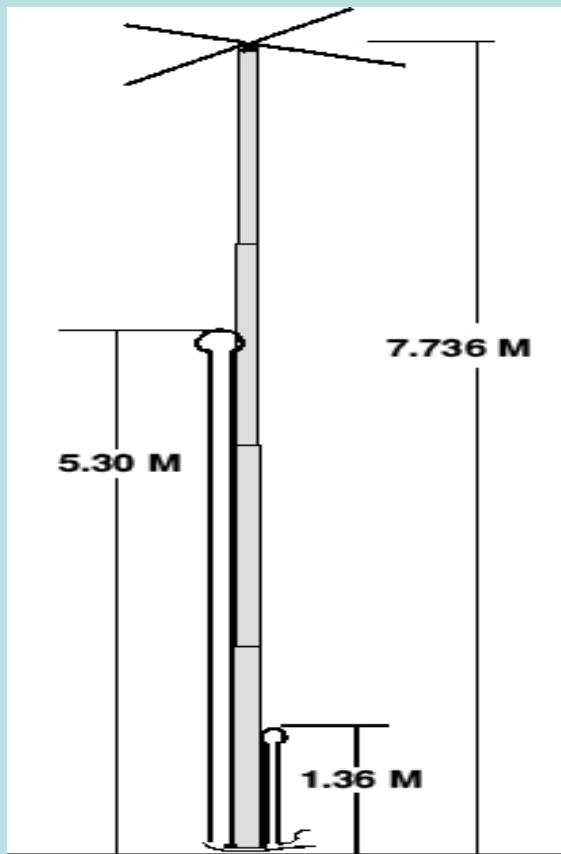

Myth: Linear Loading is more efficient than conventional coil or lumped loading

- **False**
- **If you choose your components carefully, the losses are about the same.**
- **Loading of any kind has losses greater than full size elements.**

Broadband Antennas

Reasonable efficiency:

- **Folded dipole**
- **Cage dipole**
- **Large radiator per wavelength ratios**
- **Stager tuned elements like LPA's**

Less efficient ways:

- **A resistor at the feed point (like B&W dipole)**
- **Coaxial loading**

80 meter broadband 2 wire cage dipole

This is one of my favorites. I use #12 copper wire – stranded with a plastic jacket. The 3 ft spacers are ½ inch dia. (white) PVC.

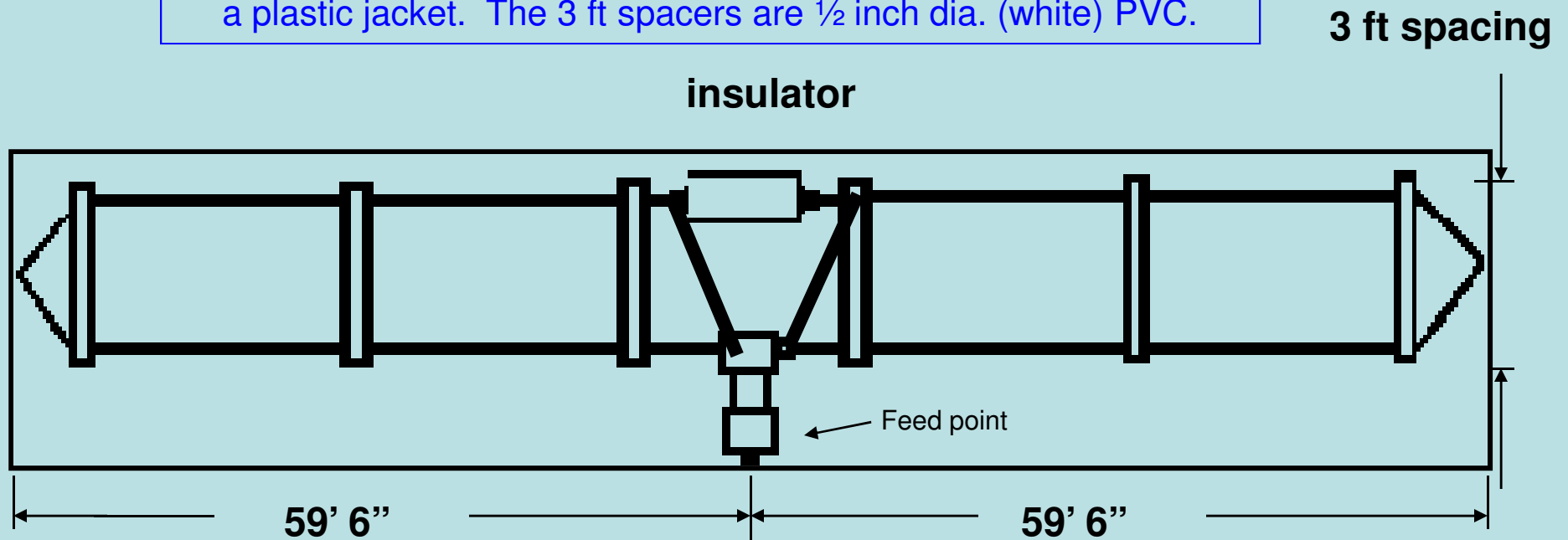

Feed with coax for 80 meters only... or if you want an “all band” “very” broad VSWR bandwidth HF dipole, feed it with open or ladder line and use an antenna tuner.

Folded dipole

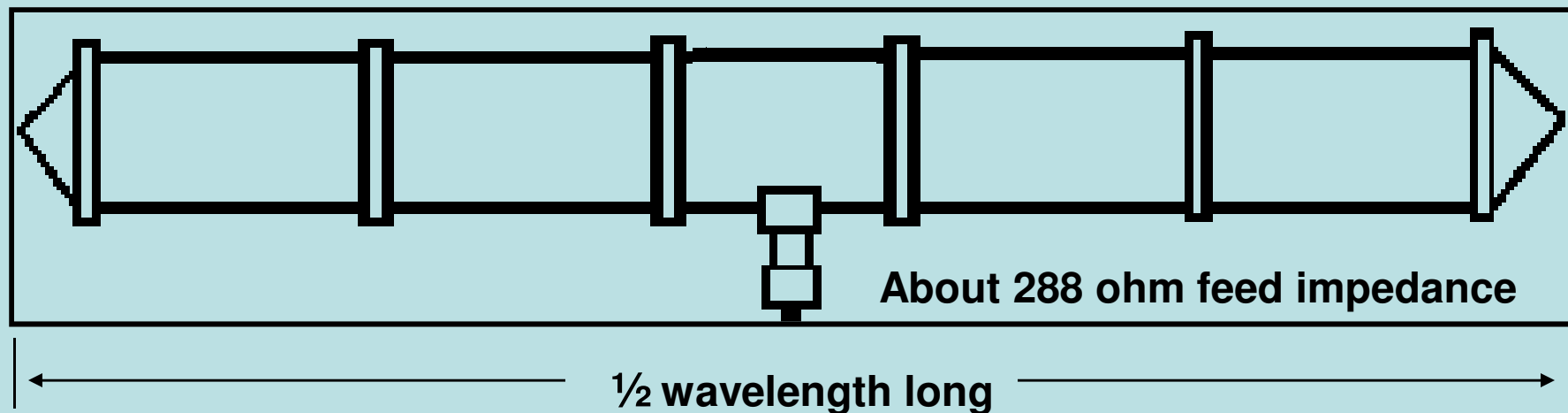

Feed with ladder line and use a tuner or use a 4:1 balun at the feed point and use coax for one band operation.

A "folded dipole has a wider VSWR bandwidth than a single wire dipole.

Antennas That Are Only *Half* There

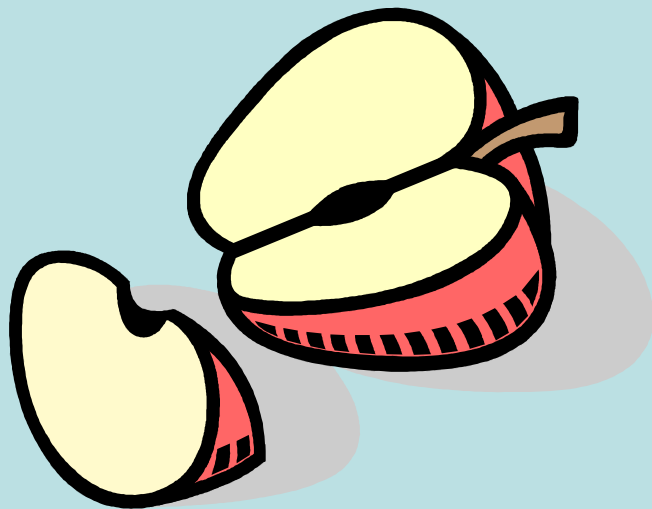

CHA-250B (Marketing hype)

The Comet CHA-250B is a newly design broadband vertical with **NO GROUND RADIALS**.

This antenna is **EXTREMELY** easy to assemble, requires no tuning or adjustments and VSWR is under 1.6:1 from 3.5-57MHz!

Where is the other half of this antenna?

What provides the balance?

The mast and feed line, of course.

Conceptually a poor design in my opinion.

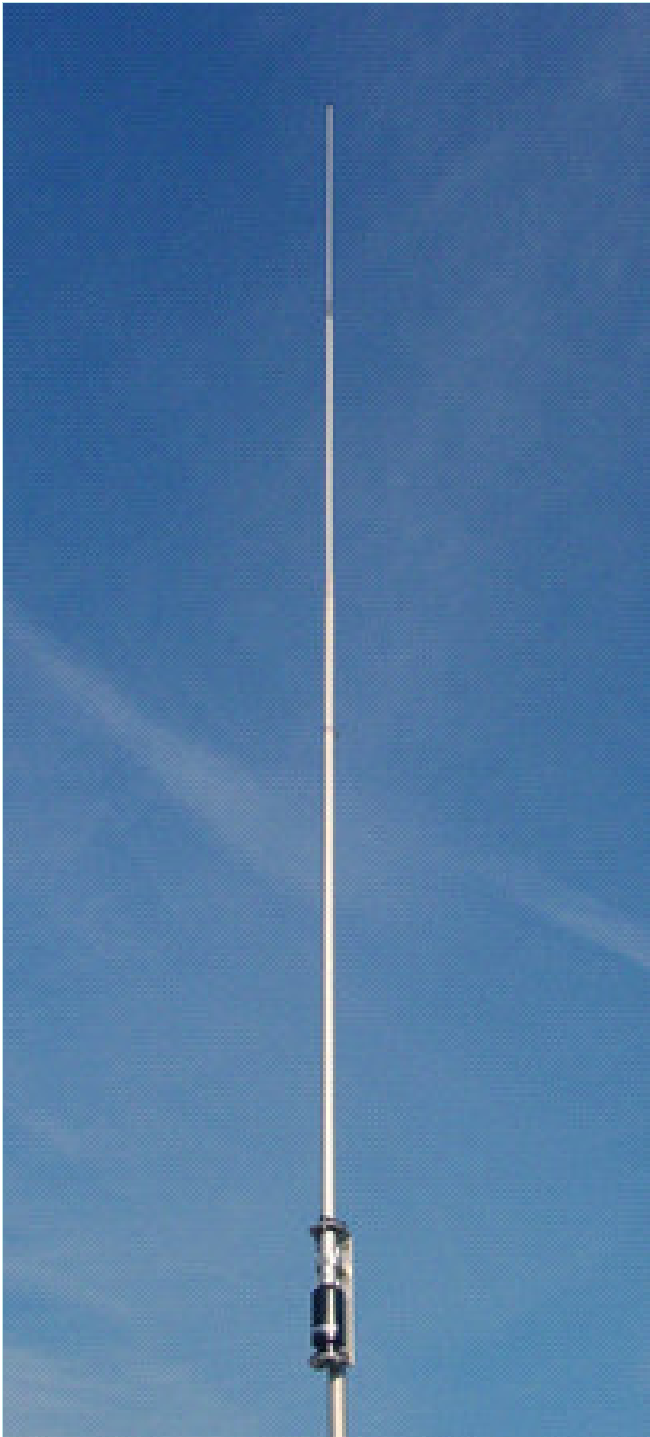

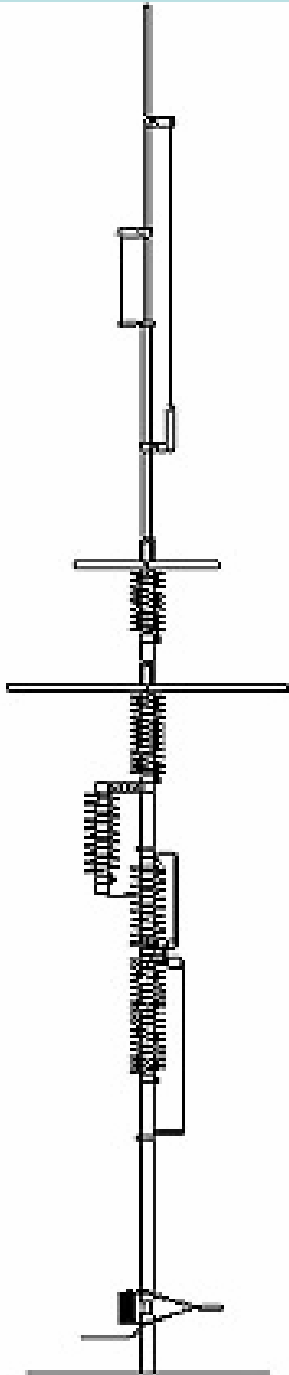

Butternut HF9V 80-6 9-Band Vertical Antenna \$495.00

Work nine popular bands; 80 thru 6 meters with an extremely efficient vertical radiator only 26 feet tall! The HF9V is an easy to erect and tune antenna that will last you for many years. No lossy traps are used in this internationally acclaimed antenna design. **No radials required with the optional CPK Counterpoise kit.** Accessory kit for 160 meter coverage available.

What is a counterpoise?

No radials? Use a counterpoise

A counterpoise is used as a substitute for the “missing” half of your antenna.

It may also be incorrectly be referred to as a ground plane, however, a counterpoise is usually skimpier than what would be considered a legitimate “ground plane.”

A counterpoise may be made with a collection of wires, pipe, plate or other conductive material that has no particular relationship to the wavelength the antenna is designed for. This is a case where “more is better.”

Your automobile metal is a counterpoise for your HF mobile antenna, since you cannot trim your car to length.

Counterpoise side effects

- Well you got away with “no radials” and used a counterpoise, but now you have RF in the shack. Why?
BALANCE !
 - Your antenna is out of balance like a wheel that is larger on one side. The common mode currents are using nearby conductive objects to attempt to balance the current flow on your antenna so that both sides are EQUAL per **Kirchhoff's current law**.
- RF current may be running down the outside of your coax shield, house wiring, mast, drain pipe and/or other nearby metal objects and into the shack. You may notice it burning your lip when you “close talk” the metal microphone or erratic behavior with your transceiver and other gear.
- **It's Time to increase the counterpoise area and/or add radials.** This will help improve balance and reduce RFI.

Basic Sigma-5 Design

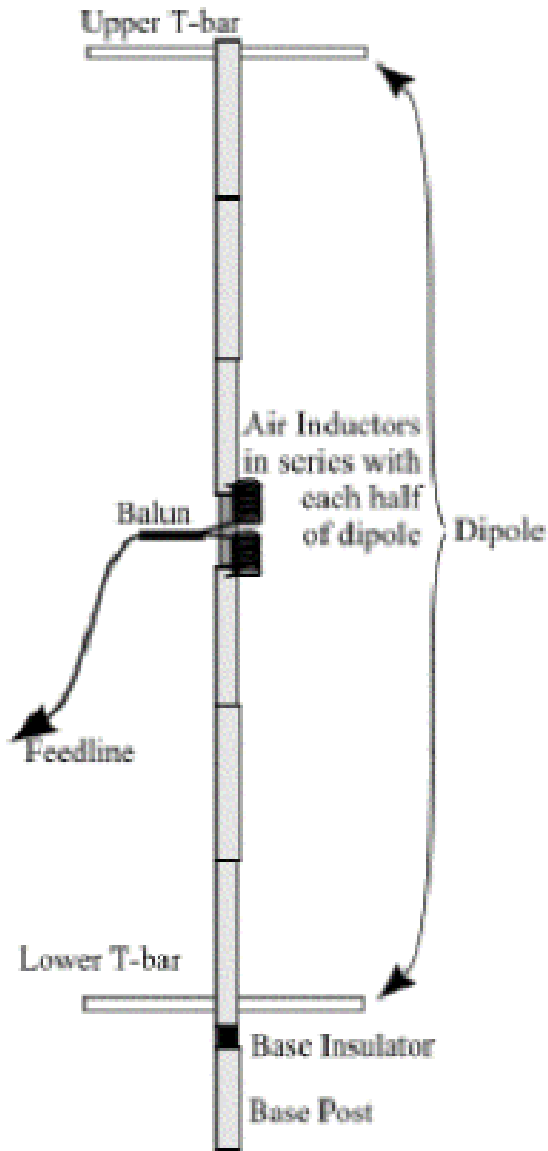

Copyright, Force 12, Inc., 2002
DW-Sigma-generic-r1

A better approach if you do not have space for radials

- A center fed vertical dipole – does not need radials because it is “complete” and balanced.
- It should not be mounted close to the earth like a ground plane may be because the dipole will interact and have “ground losses.”
- Mount it as high as you can.

Shortened vertical dipole

- SIGMA Verticals (Their marketing statement)
- *These are new Force 12, Inc. designs to provide high performance verticals on the HF bands. SIGMA's are true **vertical dipoles**, so **they do not need radials** and the real estate requirement is minimal. These antennas are the product of more than 4 years of research and development to provide the best vertical antennas in the world. The development includes testing of many types, such as empirical to validate the computer model, comparative tests with several other antennas, competitive testing ("Team Vertical", which set World and Continental records) and DXpeditions. These efforts have re-written the book on verticals and vertical antenna performance. More detail on the development of the verticals is available on this web site and others written by Kenny Silverman, K2KW (team leader of Team Vertical).*
- *SIGMA verticals are not only built for amateur purposes, but for commercial as well. They can be supplied in survival ratings up to 200 mph. Other models are lightweight and small for DXpedition and portable.*
- *The SIGMA series is the last word in verticals.*
-

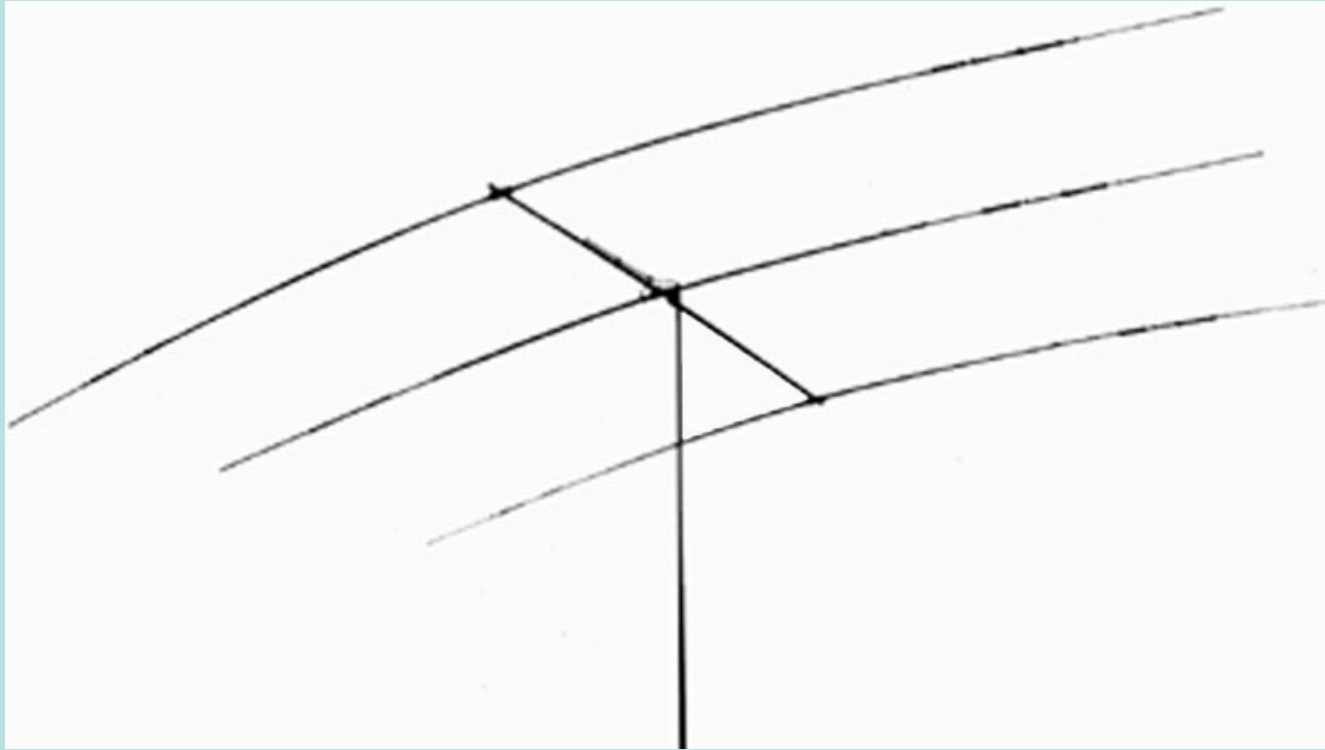

Radials are not required on 1/2 wave horizontal center fed elements

RF grounds are not needed for them either if your antenna system is working properly

I wish you success with your antenna pursuits.



Credits and References

- Reference Data for Radio Engineers, (a Sams publication.)
- *EZNEC Antenna Software* by W7EL, Roy Lewallen
- W4RNL, L.B. Cebik - <http://www.cebik.com/>
- ARRL Antenna Handbook
- Low Band DXing by ON4UN
- W8JI, Tom Rauch - <http://www.w8ji.com/>
- Greg Ordy, W8WWV - <http://www.seed-solutions.com/gregordy/Amateur%20Radio/W8WWV%20Experimentation.htm>
- K0BG's mobile radio site - <http://www.k0bg.com/>
- Reflections by Walter Maxwell, W2DU - <http://www.w2du.com/>
- Radio Antenna Engineering –by Edmund A. Laport Free book at: <http://snulbug.mtview.ca.us/books/RadioAntennaEngineering/>
- Electronic and Radio Engineering by Fred Terman
- K9STH, Glen Zook – <http://www.k9sth.com>
- *Antennas* by John Kraus, W8JK - <http://www.antennas3.com/>
- Building and Using Baluns and Ununs. Practical Designs for the Experimenter" (2nd printing 1995) Jerry Sevick, W2FMI, CQ Communications
- W5DXP, Cecil Moore - <http://www.w5d xp.com>

Happy mobiling

Thank you
for
your interest

Slide 83

TG1

Terry Graves, 1/12/2008



40 meter Hustler antenna
& ICOM 706MII on
electric scooter